

A Accessories

Common Accessories

Contact Blocks and LED Blocks for Ø16 Control Switches

Ordering Information



SA	16	CB	W		
Item	Applied switches	Type	LED color ^{※1}	LED block	
				R	Red
				B	Blue
				G	Green
				Y	Yellow
					LED block
					CB^{※2}
					Contact block
					B contact (normally closed)
					C contact (normally open, normally closed)
				L5	
				LED block	
				5VDC	
				L12	
				12VDC	
				L24	
				24VDC	
				16	
				For Ø16 control switches	
				SA	
				Switch Accessories	

※1. Only for LED blocks.

※2. Only for Ø16 emergency switches.

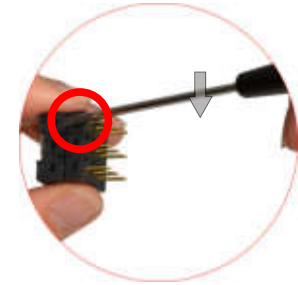
- **Contact block and LED block removal**
Separate the unit using a flat-head (-) screwdriver.



Item	Appearance	Model	Type	Features
Contact block		SA16-CB	B contact (normally closed)	For Ø16 emergency switches
		SA16-CC	C contact (normally open, normally closed)	—
LED block		SA16-L5□ (5VDC) SA16-L12□ (12VDC) SA16-L24□ (24VDC)	DC voltage type	Diverse, vibrant, high luminance LEDs (red, blue, green, yellow, white)

A Accessories

Switch Enclosures for Ø22/25 Control Switches

Ordering Information

SA	—	SB	3
Holes	1	1 hole	
	2	2 holes	
	3	3 holes	
	4	4 holes	
	5	5 holes	
Appearance	SB	Square type	
	TB	Triangle type	
Applied switches	No-mark	For Ø22/25 control switches	
Item	SA	Switch accessories	



※You can order the other size and the number of holes.

• Hole size: Ø22.5/25.5mm

(unit: mm)

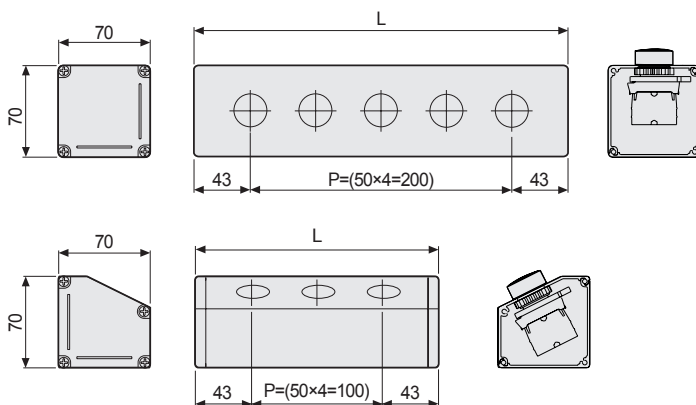

Holes	L
1	86mm
2	136mm
3	186mm
4	236mm
5	286mm













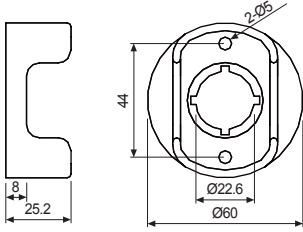

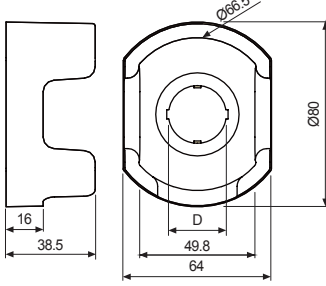
Locking Handle for Switches

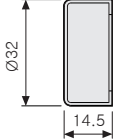
Applied switches	Appearance	Model	Note
Ø16		SA16-LH	For locking switch nuts behind the panels
Ø22/25, Ø30 ^{※1} , □30		SA-LH	

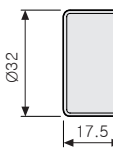
※1. Except Ø30 round pressure switches (extended).

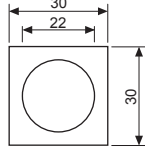
Accessories By Item

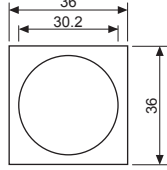
(unit: mm)

Item	Appearance	Model	Dimensions	Note						
Emergency switch nameplates		SA-NS	Size: D60×d25	Standard and illuminated nameplates are available for emergency switches. ※Illuminated nameplates are optional. ※D60 emergency switches (S2ER-E5R□) are not compatible with SA-NS nameplates						
		SA-NL	Size: D80×d25							
Protective shrouds for emergency switches		SA-EG1		Protective shrouds to prevent accidental/incorrect operation <table border="1" style="margin-left: 20px;"><tr><th>D</th><th></th></tr><tr><td>SA-EG2</td><td>Ø22.5</td></tr><tr><td>SA-EG3</td><td>Ø25.5</td></tr></table> ※Not available for D60 emergency switches (S2ER-E5R□).	D		SA-EG2	Ø22.5	SA-EG3	Ø25.5
	D									
SA-EG2	Ø22.5									
SA-EG3	Ø25.5									
		SA-EG2/ SA-EG3								
Waterproof cap for Ø22/25 round push button switches		SA-WP (non-illuminated/ extended)		IP65 protection structure with waterproof cap						
	 (extended)	SA-WL (illuminated/ extended)								
Ø20/25 Switch washer		SA-SW2		The washer helps to improve switch tightening force.						
Ø30 Switch washer		SA-SW3								
Lens remover for Ø16 push button control switches or pilot lights		SA16-RM		Lens remover for push button control switches or pilot lights						

- Control Switches
 - Ø16
 - Ø22/25
 - Ø30
 - 30
- Push Button Switches
 - Round
 - Square
 - Rectangular
- Selector Switches
 - Round
 - Square
 - Rectangular
- Key Selector Switches
 - Round
 - Square
 - Rectangular
- Double Push Button Switches
- Mushroom-head Push Button Switches
- Emergency Switches
- Pilot Lights
- Accessories
- Buzzers